

Type 8031 can be combined with...

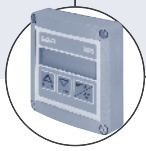

Type 8025 Low Flow

Transmitter—
wall or panel

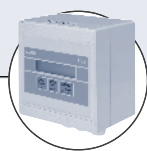

Type 8025

Batch controller—
wall or panel

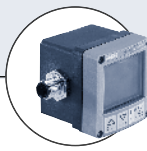

Type 8623-2

PI Controller

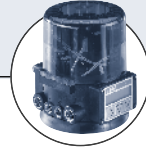

Type 8630

TopControl

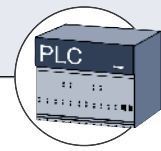

PLC

- Cost attractive solution for low flow rates and solids-free liquids
- Wetted parts made of Halar, Saphir, COREPOINT™, FKM or EPDM for use in aggressive liquids
- 3-wire system with paddle-wheel and Hall sensor up to 131°F (55°C), 145 PSI (10 bar)
- Frequency output proportional to the flow rate, PLC-compatible

The compact low-flow sensor Type 8031 with paddle-wheel and hall sensor is specially designed for use in aggressive and solid-free liquids.

The particular cost attractive measuring principle is based on a local flow velocity measurement. The sensor produces a flow proportional frequency signal which can easily be transmitted and processed.

We recommend here particularly the connection to the Burkert low-flow transmitter Type 8025 (see separate data sheet).

Technical data	
Measuring range	2.6 gph (10 l/h) to 27.0 gph (100 l/h) 5.3 gph (20 l/h) to 66 gph (250 l/h)
Accuracy	±2% of reading
Repeatability	< 1%
Ambient temperature	14°F to 131°F (-10°C to 55°C)
Storage temperature	14°F to 176°F (-10°C to 80°C)
Fluid temperature	14°F to 131°F (-10°C to 55°C)
Fluid pressure	MAX. 145 PSI at 68°F (10 bar at 20°C)
Viscosity of fluids	1 to 10 cst.
Materials	Housing: ECTFE (Halar) or POM Paddle-wheel: ECTFE (Halar) or POM Axis: Saphir or COREPOINT™ Bearings: Rubir or POM Magnets: ECTFE (Halar) encapsulated or blank Gasket: FKM, EPDM or FFKM.
K-factor	38,611 pulse/gal (10,200 pulse/liter) (range 2.6 to 27 gph) 12,870 pulse/gal (3,400 pulse/liter) (range 5.3 to 66 gph)
Output signal	Open collector NPN Pull-up resistance of 2,2 kΩ Standard feature between +VDC (white wire) and signal (green wire)
Frequency	0 to 780 Hz
Voltage supply	12–24 VDC
Electrical connection	3-wire leads (36" length)
Current consumption	max. 15 mA at 24V
Enclosure	IP67

Dimensions

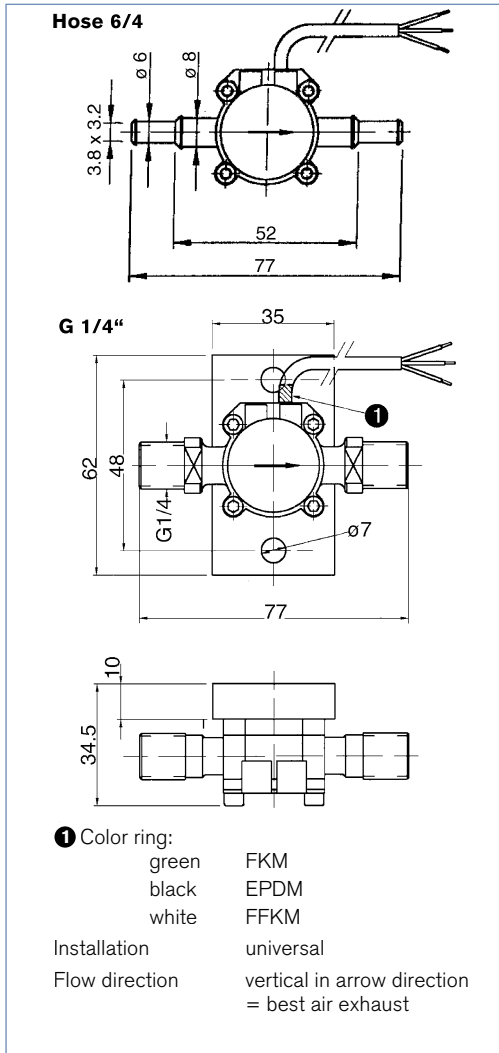

Pressure drop and K-factor curve

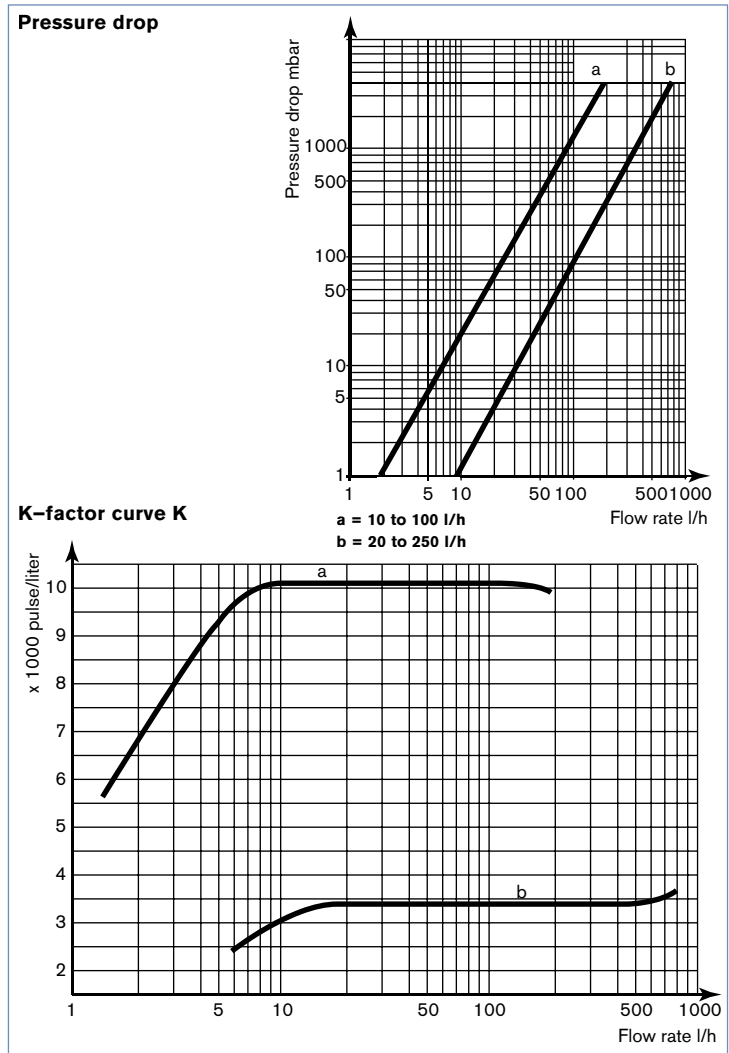

Ordering chart Low-Flow Sensor Type 8031

Measuring range	Process connection	Paddle-wheel / Axis	Gasket	Item no.
2.6 to 27.0 g/h	Hose 6 mm	POM/Corepoint	FKM	783 717
	G1/4"	POM/Corepoint	FKM	783 719
5.3 to 66 g/h	Hose 6 mm	POM/Corepoint	FKM	783 718
	G1/4"	POM/Corepoint	FKM	783 720
2.6 to 27.0 g/h	G1/4"	ECTFE/Saphir	FKM	783 721
	G1/4"	ECTFE/Saphir	EPDM	783 722
	G1/4"	ECTFE/Saphir	FFKM	783 723
5.3 to 66 g/h	G1/4"	ECTFE/Saphir	FKM	783 724
	G1/4"	ECTFE/Saphir	EPDM	783 725
	G1/4"	ECTFE/Saphir	FFKM	783 726
2.6 to 27.0 g/h	G1/4"	ECTFE/Corepoint	FKM	437 982
	G1/4"	ECTFE/Corepoint	EPDM	438 531
5.3 to 66 g/h	G1/4"	ECTFE/Corepoint	FKM	438 532
	G1/4"	ECTFE/Corepoint	EPDM	437 524

In case of special application conditions, please consult for advice.

We reserve the right to make technical changes without notice.

0602/3_US-en